

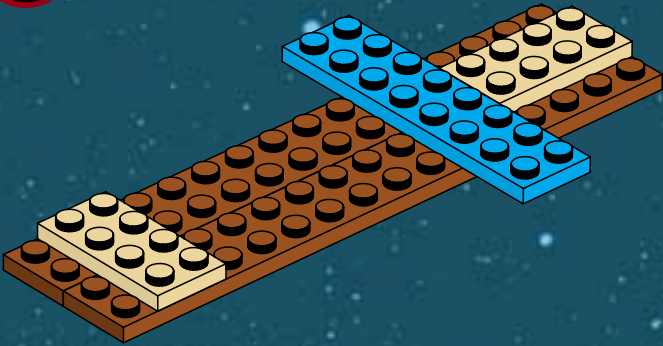

7155

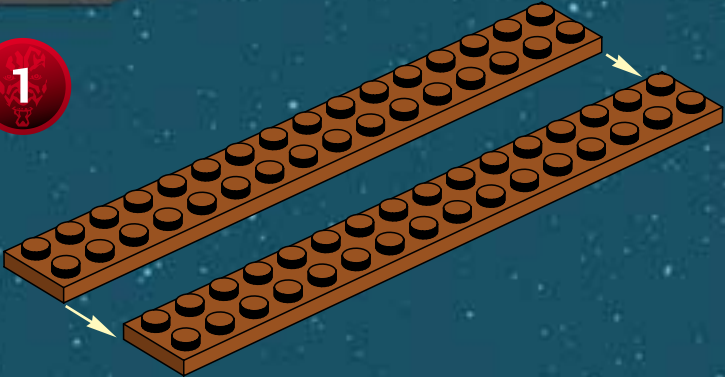

TRADEFEDERATION AAT™

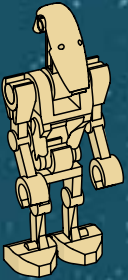
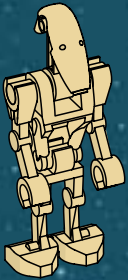
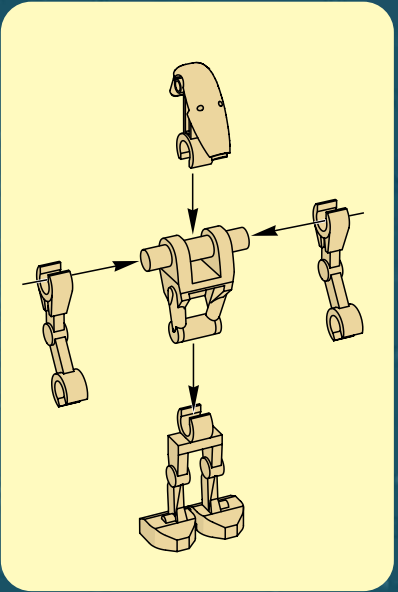
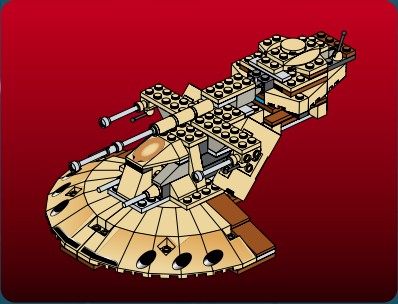
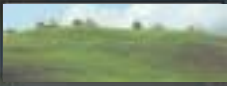

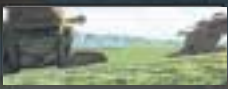

3

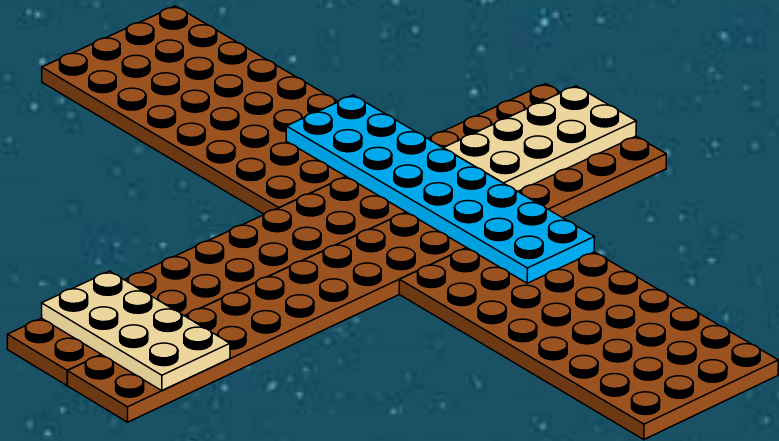

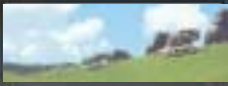

4





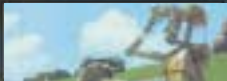

5

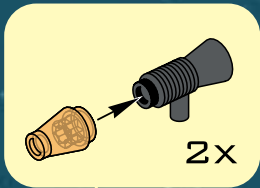

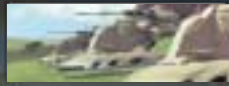

6

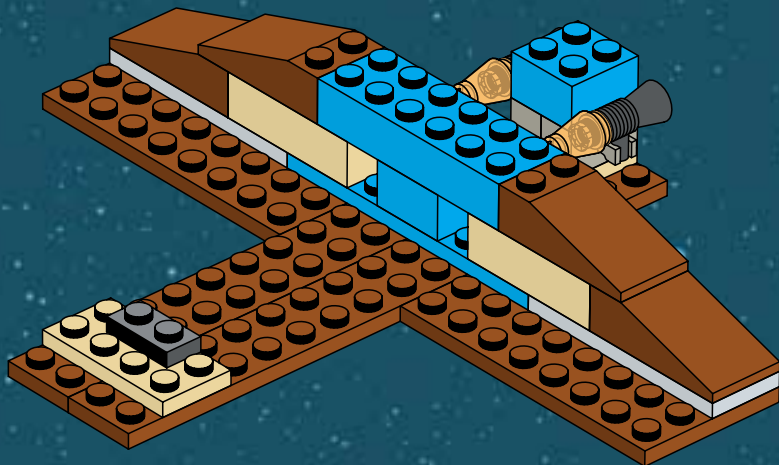

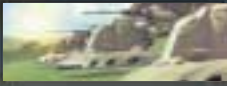

7

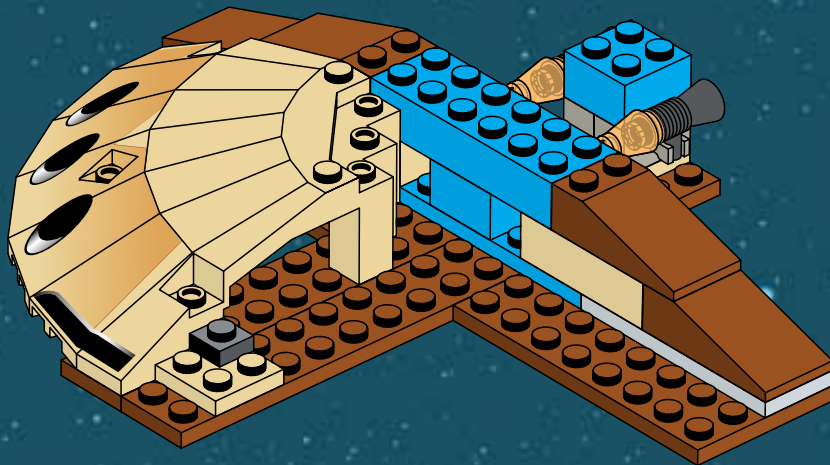

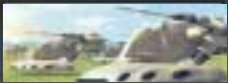

8

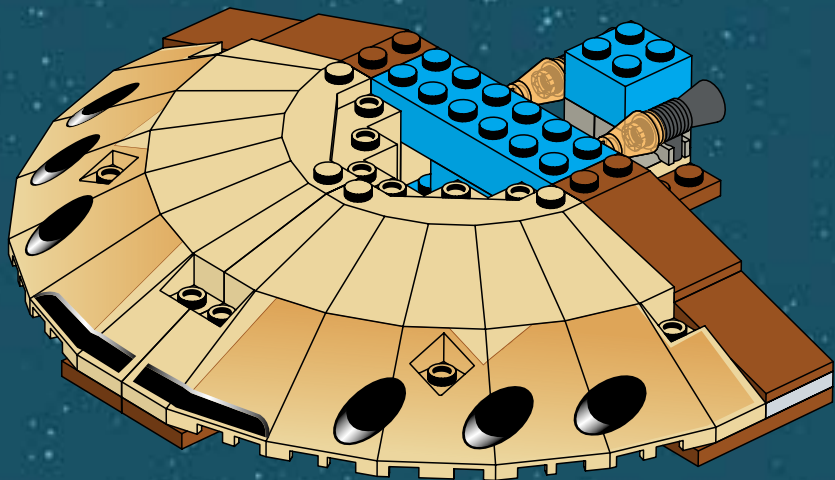



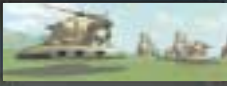

9





10

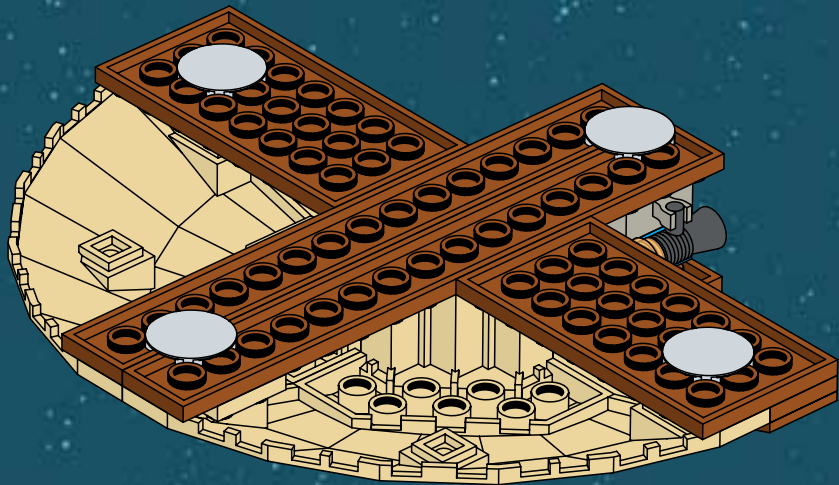

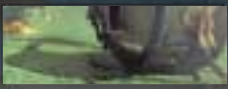

11



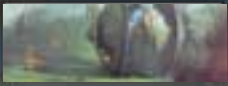

12



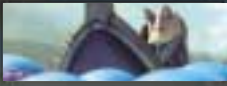

13

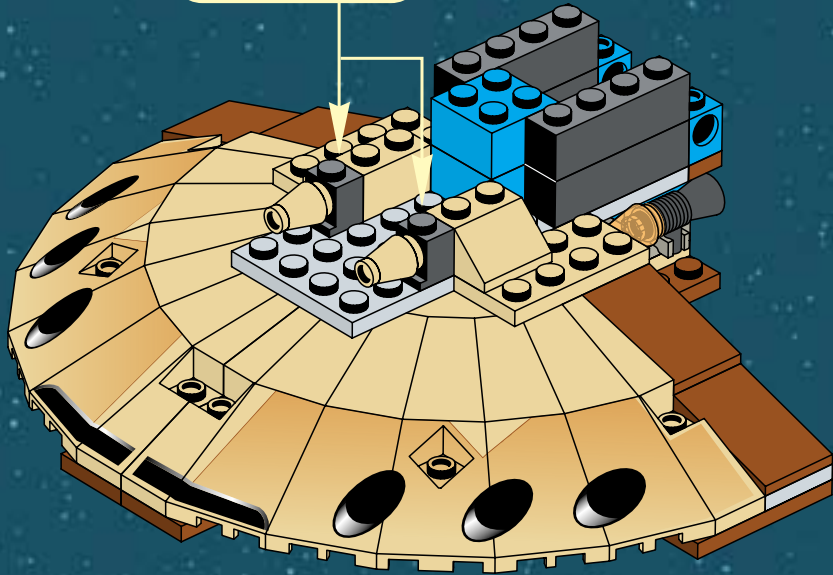
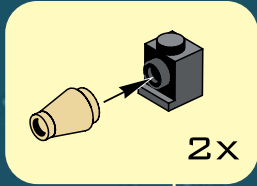



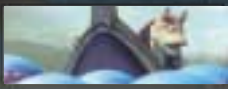

14

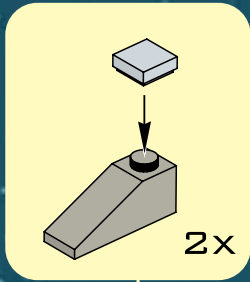



15

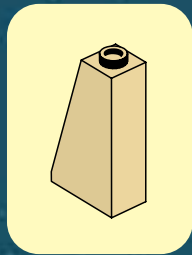

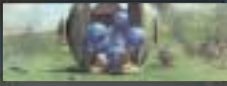

1

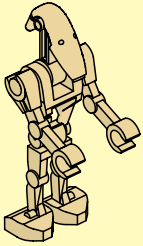

2

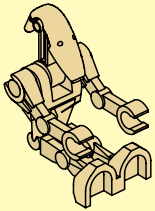

16

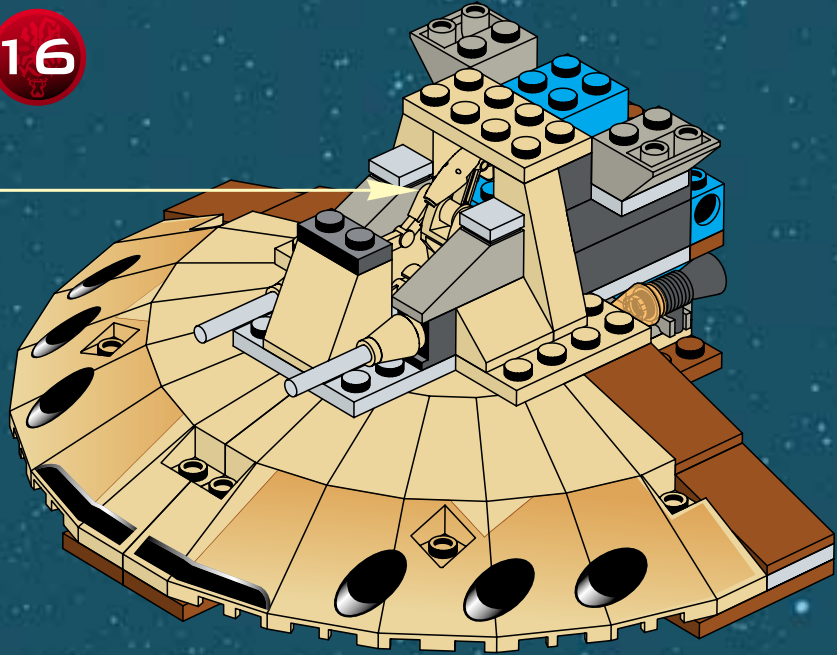



17

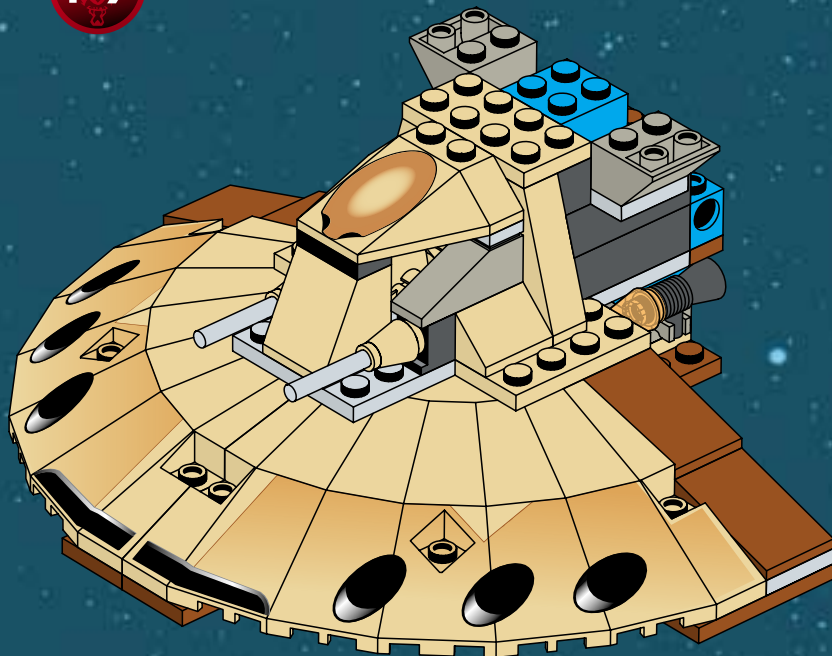

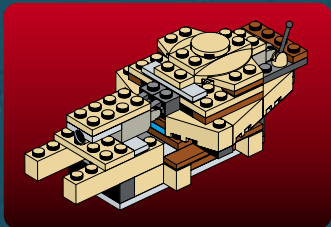

1

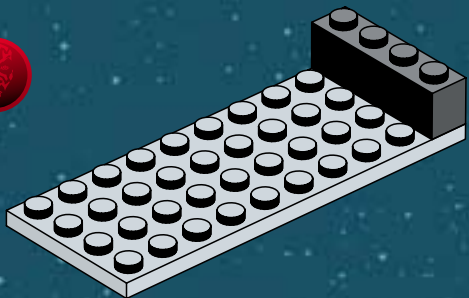

2

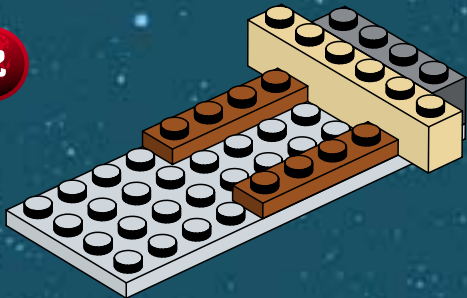

3

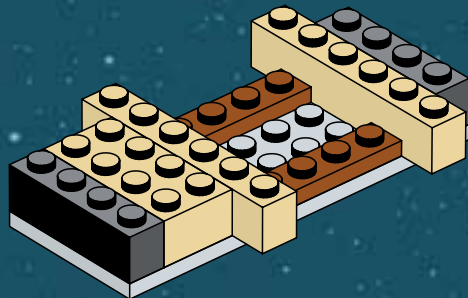

4





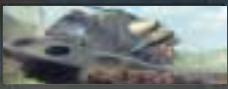

5

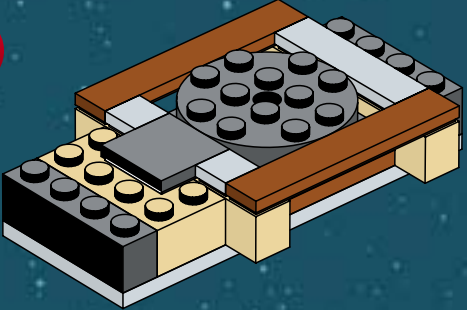

7



6

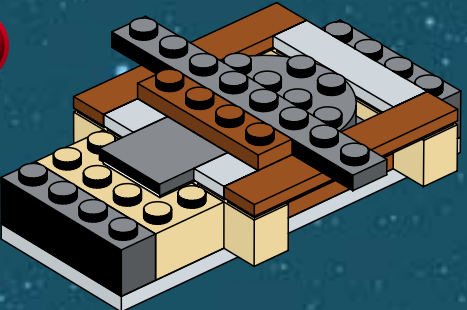

8

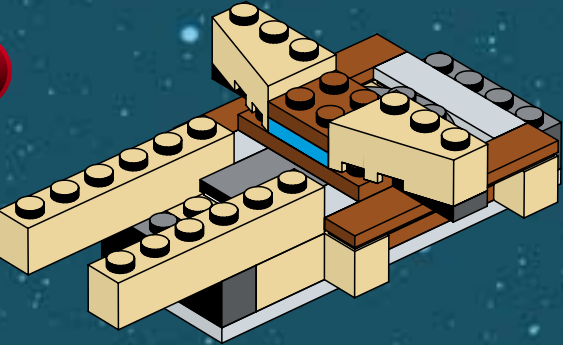

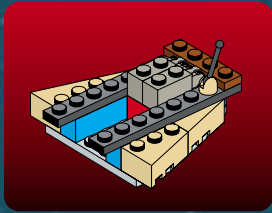

1

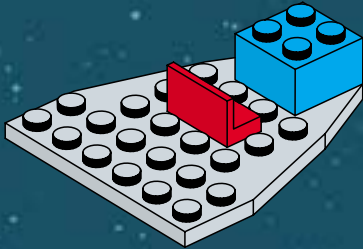

2

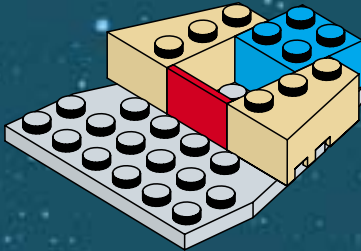

3

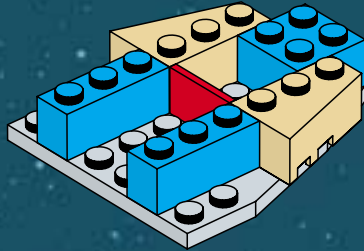

4

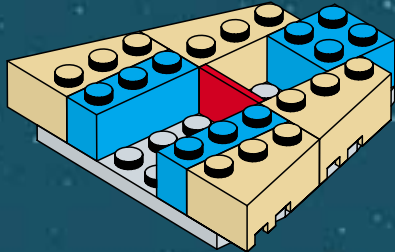

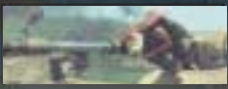

5

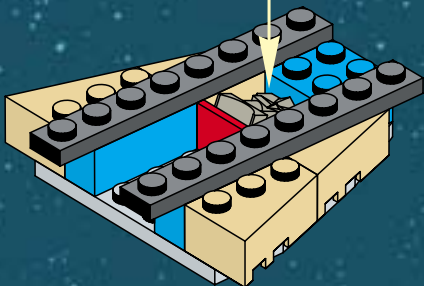

6

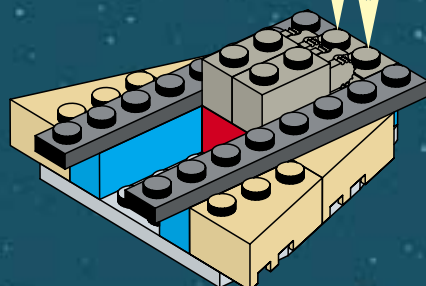
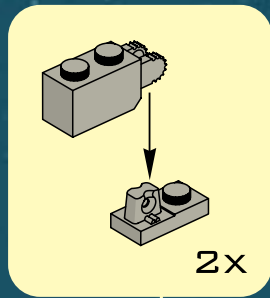

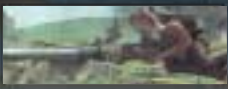

7

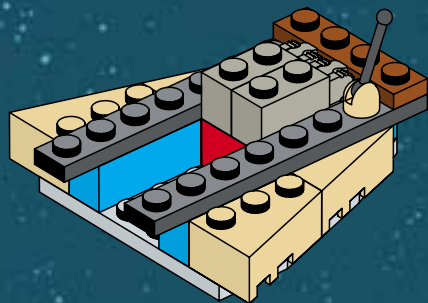

9

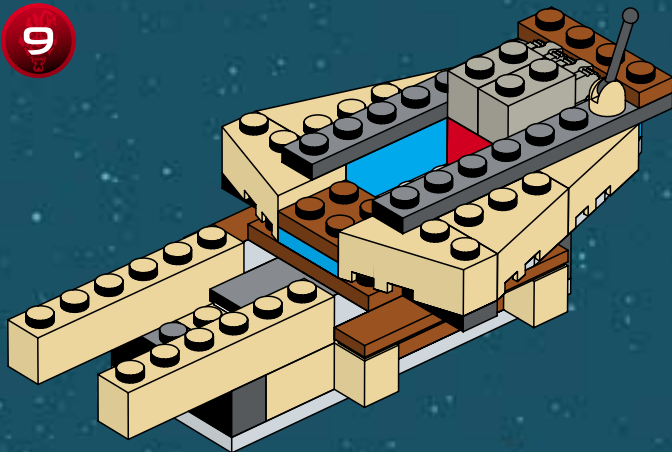

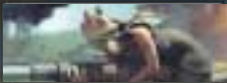

10

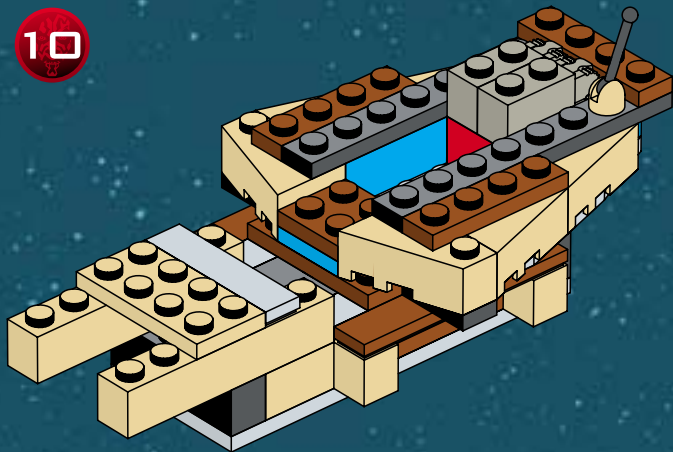

11

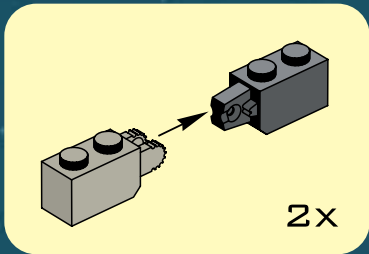

2x



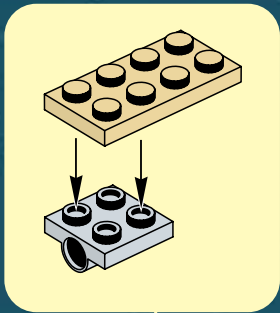
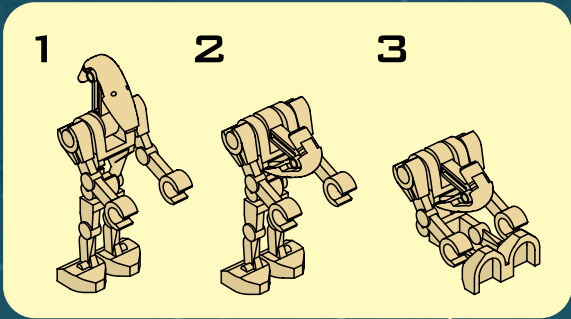
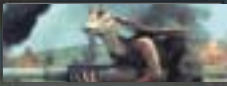

12

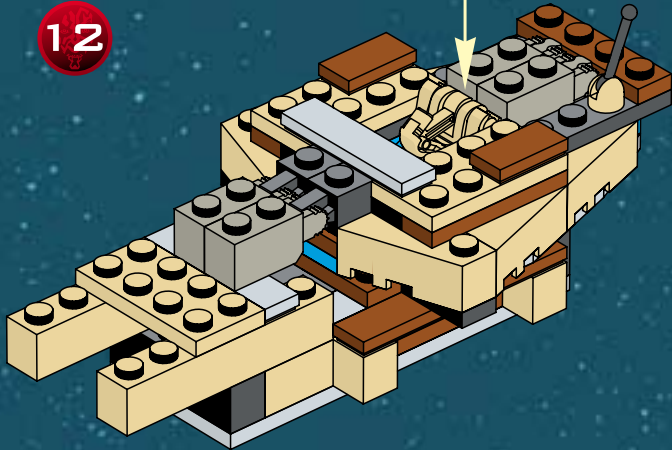

13



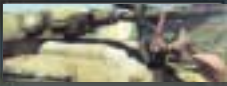

18

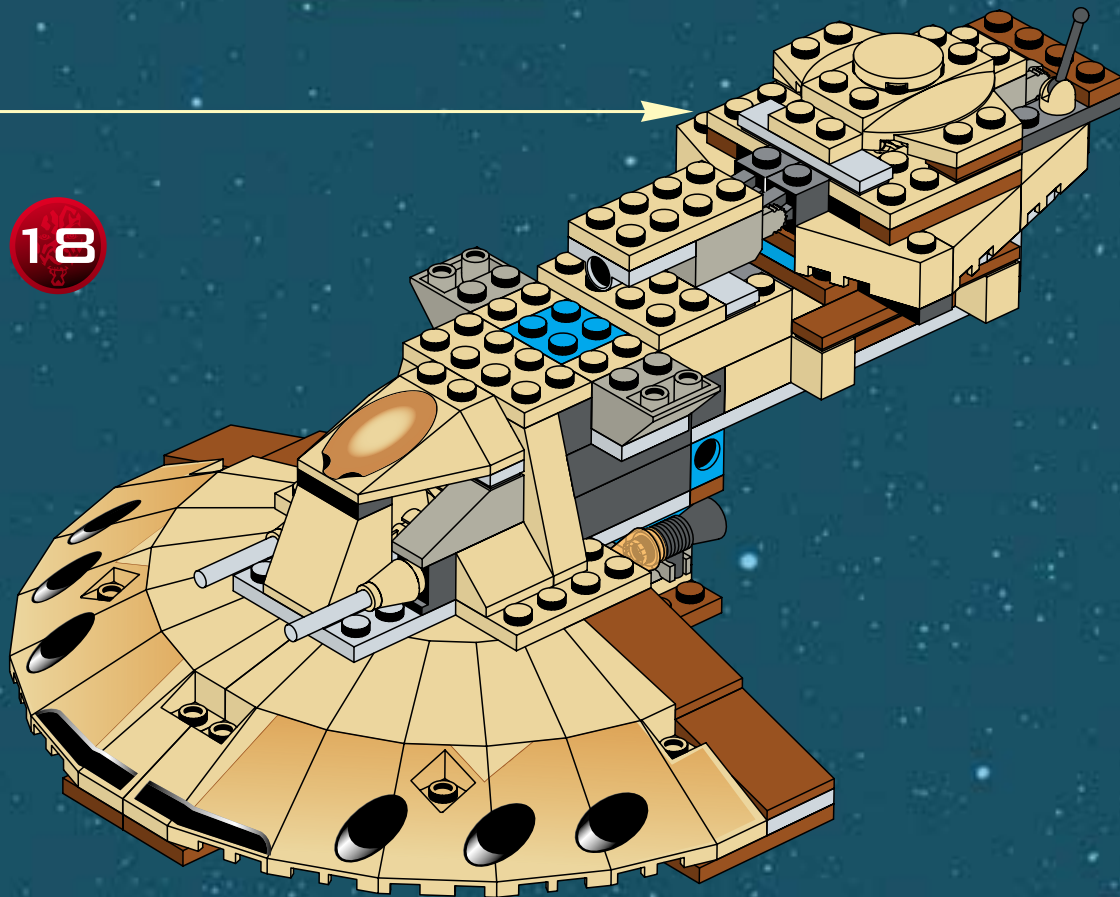

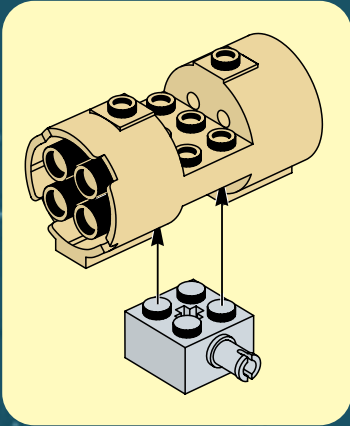
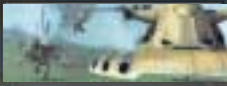

19

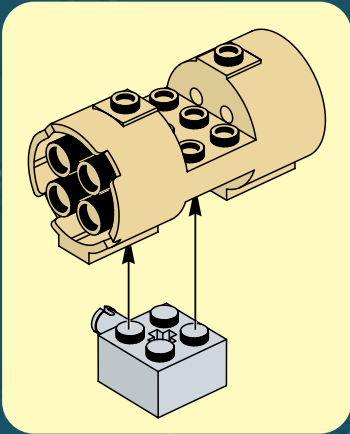
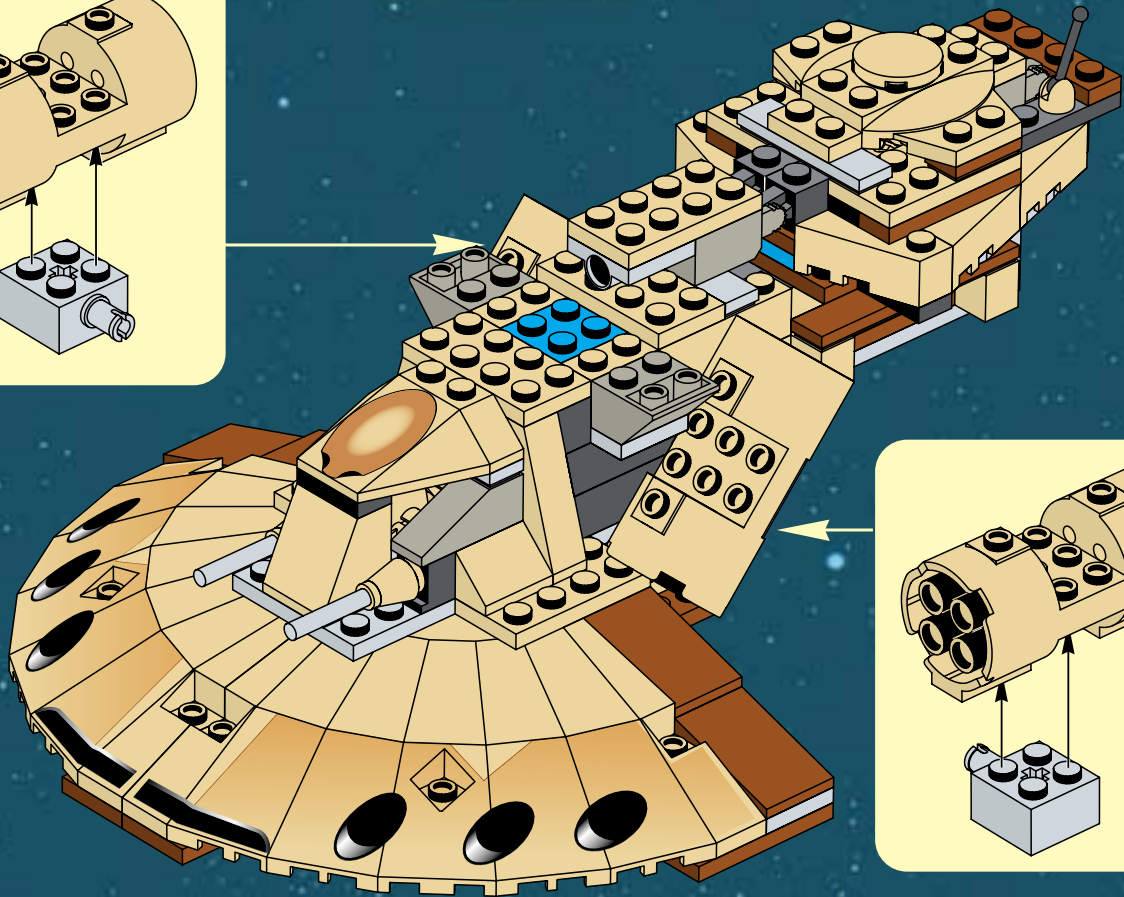



20

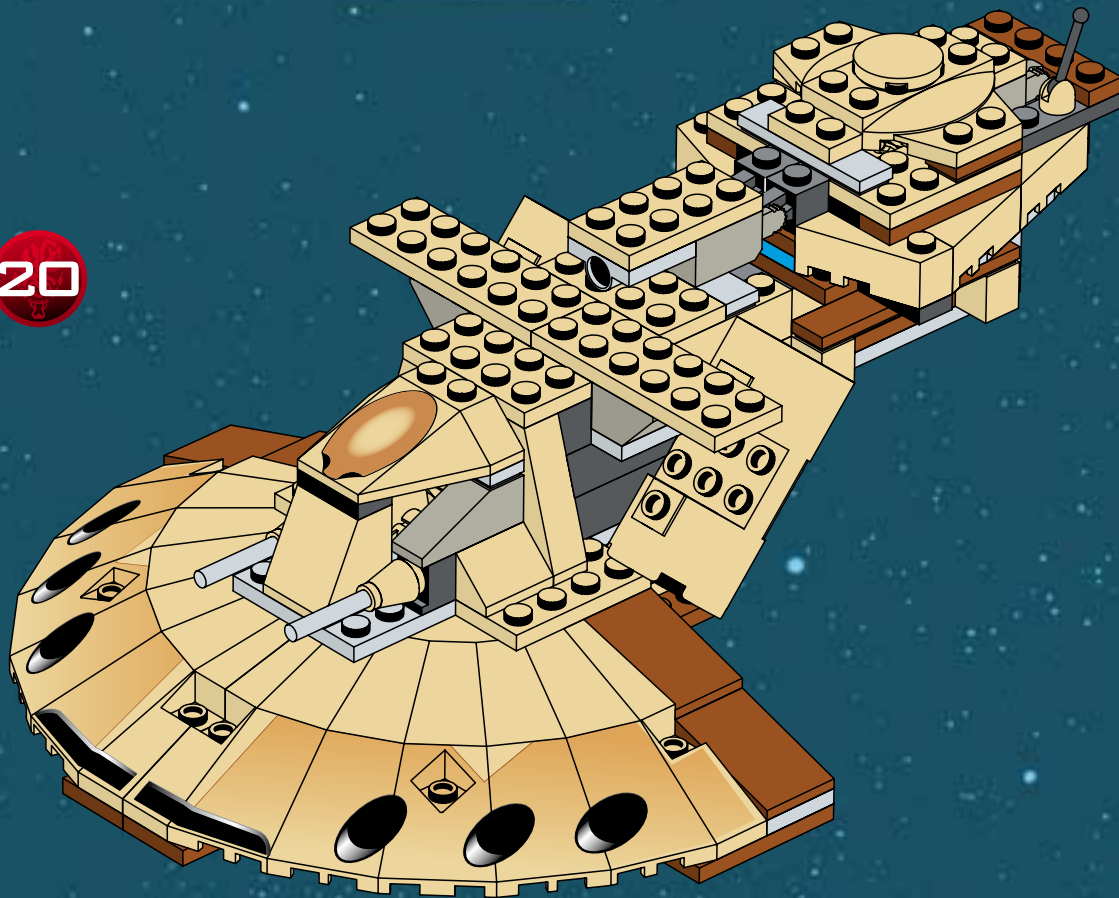



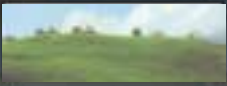

1

2

21

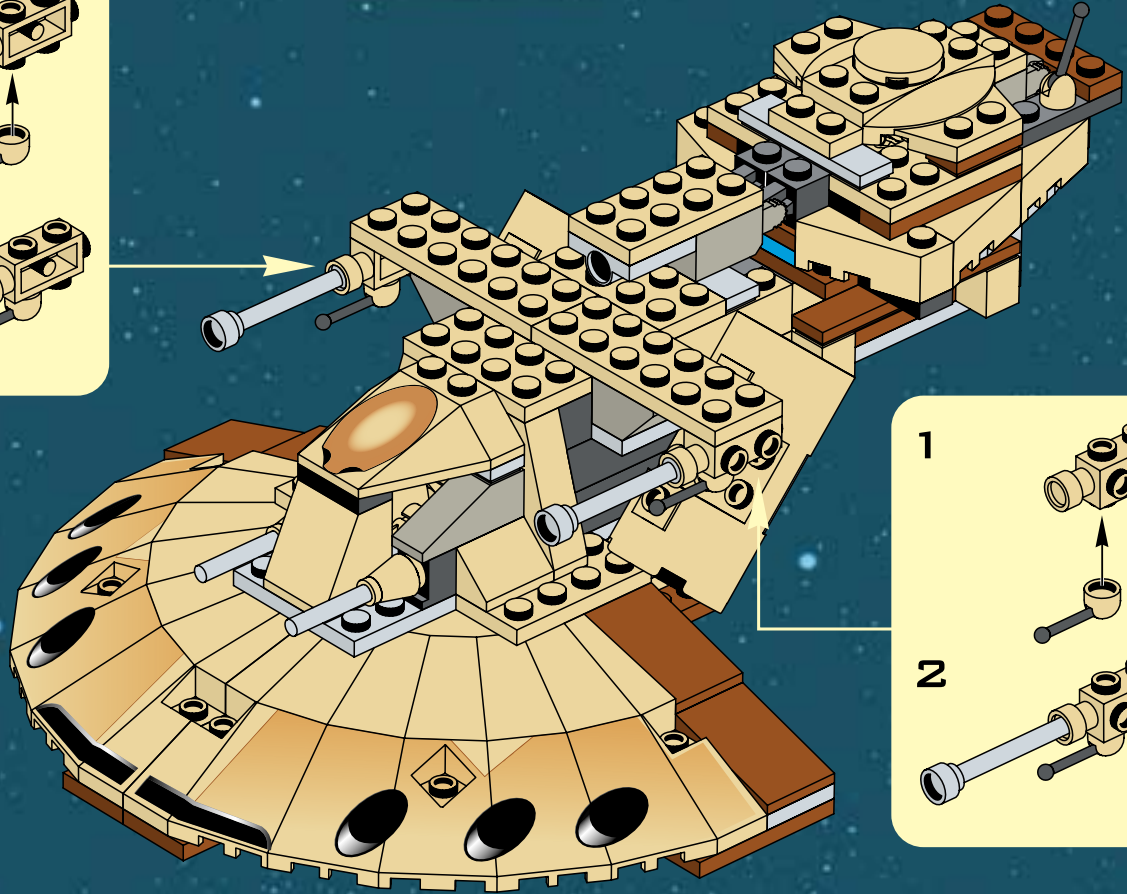

1

2





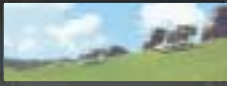

22

